

Safezone222-NC Specification Sheet

Safezone222-NC Filtered Far UVC Excimer Lamp Surface Mount

UVC Cleaning Systems Inc. is introducing the Safezone222-NC UV device. The Safezone222-NC is our in ceiling mounted filtered 222nm Far UVC solution for microbial pathogen reduction applications. With optimal mounting flexibility the Safezone222-NC product is highly effective at pathogen reduction in numerous areas and applications.

Featuring Care222® Krypton-Chloride excimer UV modules that can safely be used in occupied spaces without posing health risks to humans, the Safezone222-NC system needs to be part of your disinfection process. The 222nm Far field UVC revolution is setting a new standard in microbial virus and bacterial reduction that you never dreamed of before!

FEATURES & BENEFITS

- iOS App Store Compliant
- Meets ACGIH® UV Exposure Limits.
- Flexible Mounting on Vertical Surfaces
- Simple Lamp Mounting Options
- Care222® Patented Safety Filter Technology Included to Ensure Narrowband 222nm Emission
- Mercury Free - Environmentally Friendly
- Effective Germicidal Wavelength to Eliminate Dangerous Pathogens
- Effective Reduction of Viruses, Bacteria, and Spores
- Instantaneous On/Off at Full Output Power, No Lamp Degradation
- No Lifetime Instantaneous On/Off at Full Output Power

APPLICATIONS

- Surfaces • Air



Safezone222-NC

UVC Output/Beam Angle:

14 uw/cm² @ 1meter/ 60 Degree

Effective Against: Bacteria, Mold, Yeast, and Virus

Electrical: 120-277 VAC, .5 AMPS, 50/60 Hz

Dimensions (Arms Open): 12 5/8" H x 7 5/8" W x 24 3/4" D

Weight: 3 lbs. 13 oz.

 **Complies with**
ANSI / UL / CSA 8802
E115876 UL 1598 / CSA C22.2#250.0



USHIO

EPA Est.
#91447-MI-2



Phone: 810-358-7202
E-mail: customerservice@uvc-inc.com
Website: www.uvc-inc.com

Safezone222-NC Specification Sheet

Irradiance Distribution

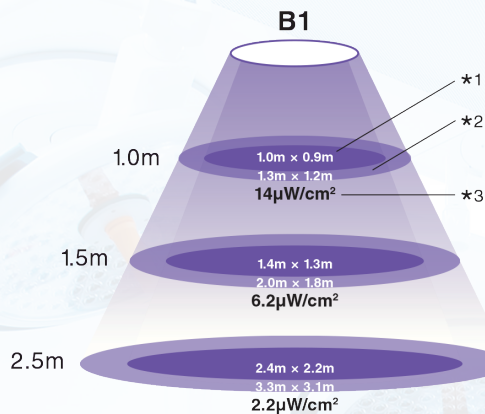

- *1 Area of >60% Peak Irradiance
- *2 Area of >30% Peak Irradiance
- *3 Peak Irradiance

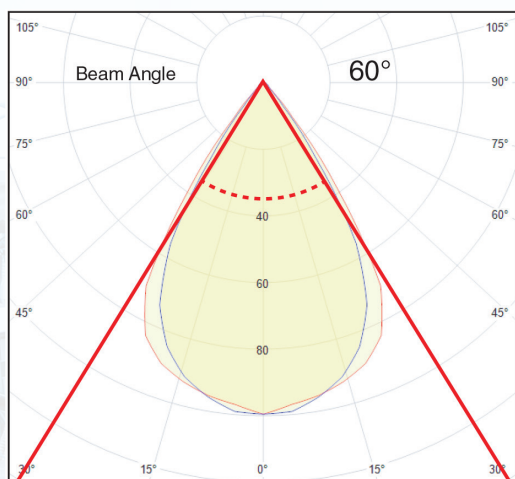

Safezone222 Front View

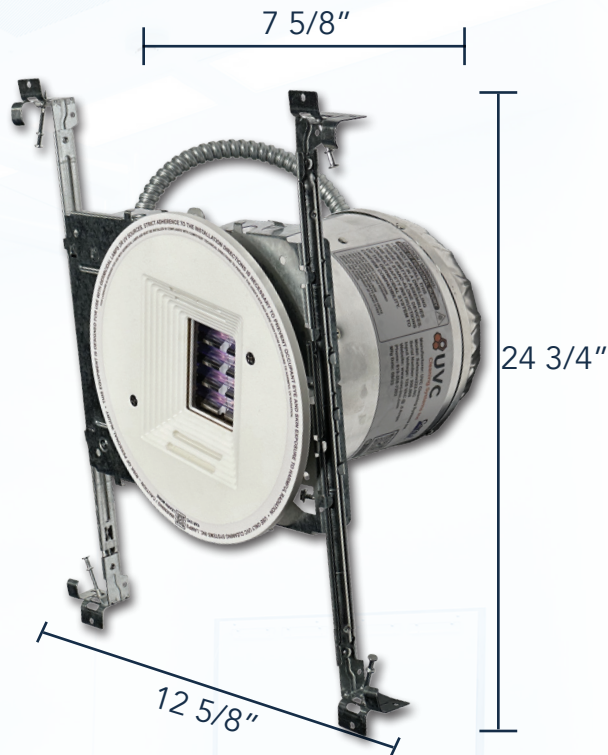

Product Name

Safezone222-NC

Wavelength

Filtered 222nm

Beam Angle

60°

Optical Filter

Yes

Optical Diffuser

No

Output (Center Irradiance @1m)

14uW/cm2

Electrical Input (Inverter)

120-277 VAC, .5 AMPS

Power Consumption

20W

Operating Voltage

4kV – 6kV

Average Rated Lamp Life

10,000hr (80% Output)

Dimensions (in)

12 5/8"H x 7 5/8"W x 24 3/4"D



SCAN ME

Regulatory Approvals and Partnerships:



Complies with
ANSI / UL / CSA 8802
UL 1598 / CSA C22.2#250.0



EPA Est.
#91447-MI-2

Safezone222-NC Specification Sheet

Domain	Species	Methods ¹⁻⁷				
		222nm	254nm	70% ethanol	405nm	
Bacteria	MRSA (<i>Methicillin-Resistant Staphylococcus aureus</i>)	+++	+++	+++	+	
	<i>Pseudomonas aeruginosa</i>	+++	+++	+++	+	
	<i>Escherichia coli</i> O157	+++	+++	+++	+	
	<i>Salmonella Typhimurium</i>	+++	+++	+++	+	
	<i>Campylobacter jejuni</i>	+++	+++	N.D.	+	
	<i>Bacillus cereus</i>	Vegetative cell	+++	+++	++	+
		Spore	+++	++	—	—
	<i>Bacillus subtilis</i>	Vegetative cell	+++	+++	N.D.	+
		Spore	+++	++	N.D.	—
	<i>Clostridium difficile</i>	Spore	+++	++	—	—
Molds and Yeasts	<i>Candida albicans</i>	+++	+++	+++	+	
	<i>Penicillium expansum</i>	+++	+++	N.D.	+	
	<i>Aspergillus niger</i>	Vegetative cell	+	+	+++	+
		Spore	+	+	N.D.	—
Virus	MS2	+++	+++	N.D.	—	
	<i>Feline Calicivirus</i>	+++	+++	—	—	
	<i>Influenza A</i>	+++	+++	N.D.	—	
	<i>SARS-CoV-2</i>	+++	+++	N.D.	—	

Table X, Inactivation effect of 222-nm, 254 nm UVC irradiation and 70% ethanol on the various species. Dose of UVC radiation to achieve 3-log reduction of the species is grouped as follows. <50 mJ/cm²: +++, ~100 mJ/cm²: ++, ~1000 mJ/cm²: +, >1000 mJ/cm²: -. Treatment time with 70% ethanol to achieve 3-log reduction of the species is grouped as follows. <10 sec: +++, ~20 sec: ++, ~30 sec: +, >30 sec: -. **N.D. means no data.** The data shown in green were studied and provided by Ushio Inc.

Reference

1. CM Springorum et al., Conference: XIV international congress of the International Society for Animal Hygiene, At Vechta, Volume: 2, Page 740-742, 2009
2. D Wang, T Oppenländer, MG El-Din, and JR Bolton, "Comparison of the disinfection effects of vacuum-UV (VUV) and UV light on bacillus subtilis spores in aqueous suspensions at 172, 222 and 254 nm," Photochem. Photobiol., vol. 86, no. 1, pp. 176-181, 2010.
3. A. N. Edwards, S. T. Karim, R. A. Pascual, L. M. Jowhar, S. E. Anderson, and S. M. McBride, "Chemical and stress resistances of clostridium difficile spores and vegetative cells," Front. Microbiol., vol. 7, no. OCT, pp. 1-13, 2016.
4. S. E. Beck, H. B. Wright, T. M. Hargy, T. C. Larason, and K. G. Linden, "Action spectra for validation of pathogen disinfection in medium-pressure ultraviolet (UV) systems," Water Res., vol. 70, pp. 27-37, 2015.
5. J. C. Doultree, J. D. Druce, C. J. Birch, D. S. Bowden, and J. A. Marshall, "Inactivation of feline calicivirus, a Norwalk virus surrogate," J. Hosp. Infect., vol. 41, no. 1, pp. 51-57, 1999.
6. Kitagawa, et al. (2020) DOI: <https://doi.org/10.1016/j.ajic.2020.08.022>.
7. Welch, et al., Sci. Rep. 8, 2752 (2018). Buonanno, et al., Sci. Rep. 10, 10285 (2020).

Safezone222-NC Specification Sheet

UV-C COMPARISON STUDIES

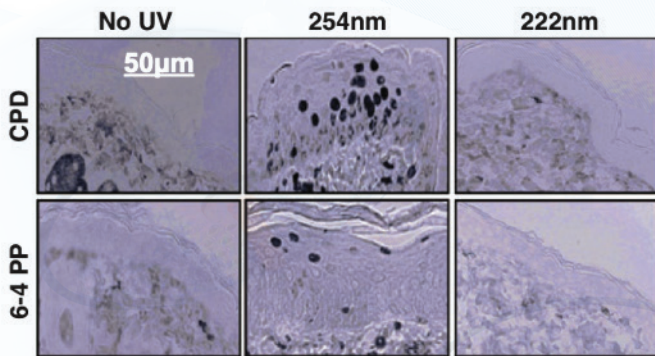

Fig. 1 Comparison of cross-sectional images of UVC-induced premutagenic skin lesions CPD (cyclobutane pyrimidine dimers) and 6-4PP (photoproducts) in the dorsal epidermis of mice. A UV dose of 157 mJ/cm² was used for both 254 and 222 nm¹.

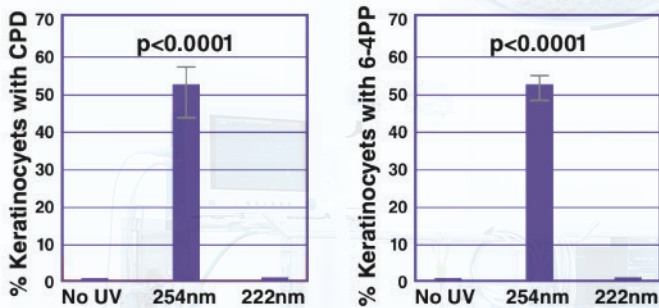

Fig. 2 & 3 Average percent of keratinocyte cells exhibiting dimers (Fig 2. - right CPD; Fig 3. - left 6-4PP) measured in UVC-induced premutagenic DNA lesions in nine randomly selected fields of view per mouse (n=3).

Comparison (254nm VS 222nm) for Spore Inactivation²

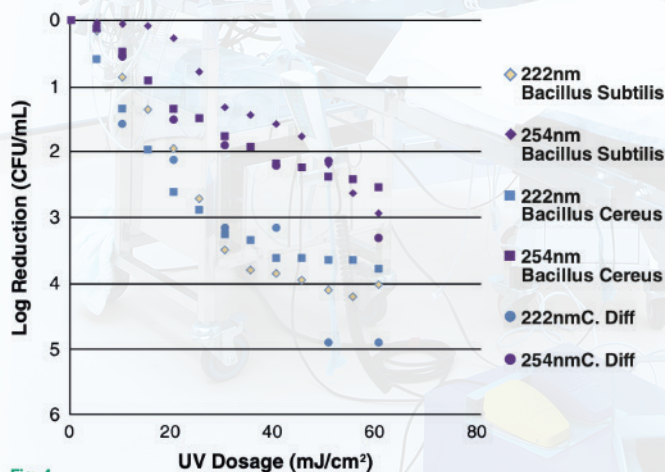
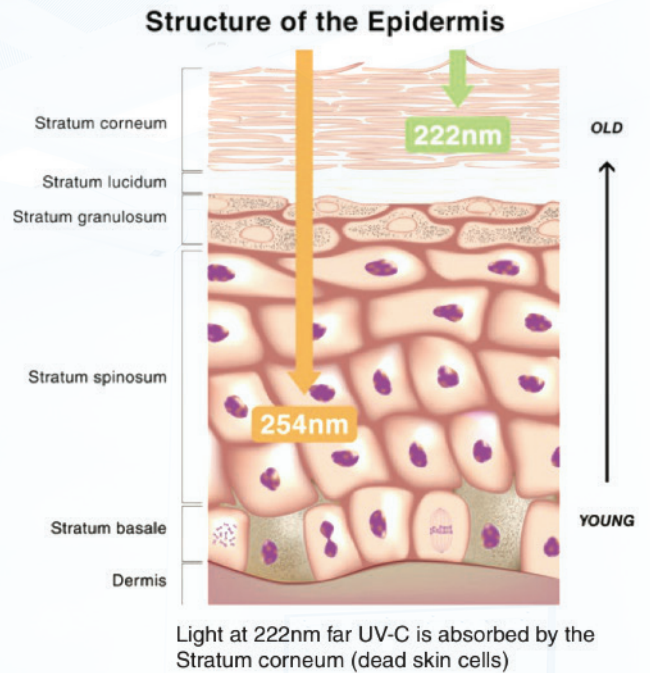

Fig. 4

References:

- Buonanno, Manuela; Ponnaiya, Brian; Welch, David; Stanislaukas, Milda; Randers-Pehrson, Gerhard; Smilenov, Lubomir; Lowy, Franklin D.; Owens, David M.; Brenner, David J. Germicidal Efficacy and Mammalian Skin Safety of 222nm UV Light. Radiation Research. 2017 April; 187(4): 483-491.
- Ushio Inc. Internal Data
- Kolozsvári, Lajos; Nógrádi, Antal; Hopp, Béla; Bor, Zsolt. UV Absorbance of the Human Cornea in the 240- to 400-nm Range. Investigative Ophthalmology & Visual Science July 2002, Vol.43, 2165-2168.

SKIN ABSORPTION SHOWING 222nm VS. 254nm



DAMAGE OF CORNEA

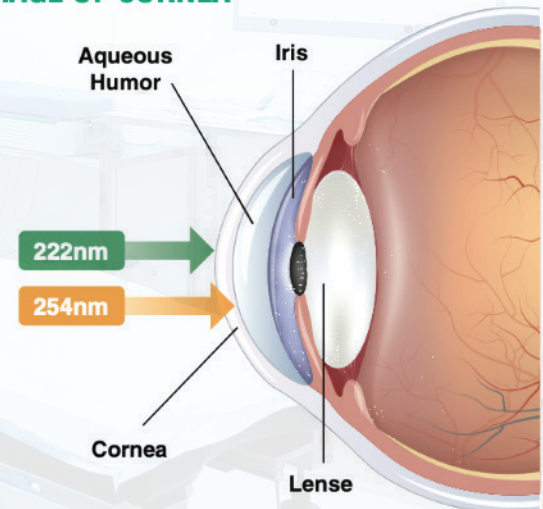

Unlike conventional UV light, 222nm far UV-C is absorbed in the tear layer of the cornea and is much less likely to cause eye damage.³

All safety testing was done with Ushio's proprietary filter technology to provide only narrowband 222nm light emission.